

目录

1. 命名规则 Naming Rules.....	3
2. 技术参数 Performance Parameters.....	3
3. BMU 安装设计参考 BMU installation bin design reference.....	4
3.1 BMU 内嵌安装 Embedded installation.....	4
3.2 BMU 外置安装 External installation.....	5
4 接口定义 Interface Definition.....	6
4.1 12~16S BMU Interface Definition.....	6
5. BMU 配件清单 Accessories list.....	9
6. 注意事项 Precautions.....	10
7. 免责声明 Disclaimer.....	11

1. 命名规则 Naming Rules

BMU[Ⓐ][Ⓐ]-[Ⓑ][Ⓑ]S[Ⓒ][Ⓒ]T[Ⓓ][Ⓓ]F

ⒶⒶ:硬件版本号 Hardware version

ⒷⒷ:电芯串数 Number of battery strings

ⒸⒸ:温度探头个数 Number of temperature sensors

ⒹⒹ:外接风扇额定电压 Rated voltage of external fan

如: BMU07-16S08T48F, 表示硬件版本号为 07, 16 串电芯 8 个温度, 驱动额定电压 48V 的风扇

For example: BMU07-16S08T48F, which means that the hardware version number is 07, 16 battery cells and 8 temperatures, driving a fan with a rated voltage of 48V

2. 技术参数 Performance Parameters

适用电池类型 Suitable for battery	磷酸铁锂电池 Lithium-ion	
温度检测 Temperature detection	数目 Number	8
	精度 Accuracy	±2℃
	量程 Range	-30~100℃
电压检测 Voltage detection	数目 Number	16S
	精度 Accuracy	±10mV
	量程 Range	0~5V
均衡方式 Balance Type	被动均衡 Passive equilibrium	
均衡电流 Balance Current	100 mA@3.5V	
风扇 Fan	模组额定电压非 48V, 电流小于 500mA@12V Rated voltage is not 48V: current less than 500mA	
	模组额定电压为 48V, 电流小于 1000mA 48V Rated voltage is 48V: current less than 1000mA	
通信方式 Communication	CAN 2.0B	
供电 Power supply	12V DC	
功耗 Power consumption	≤20mA	

尺寸 Dimensions	155*89*26mm (W*H*D) ,详见 3D 图 please refer to 3D drawing
重量 weight	0.51kg(with iron shell)

3. BMU 安装设计参考 BMU installation bin design reference

3.1 BMU 内嵌安装 Embedded installation

在电池模组内部，预留好 BMU 左右两侧接线空间。并设计可拆卸仓盖，见下图：

The BMU is embedded in the battery module, and the wiring space on the left and right sides of the BMU is reserved. The detachable cover is designed, as shown in the figure below

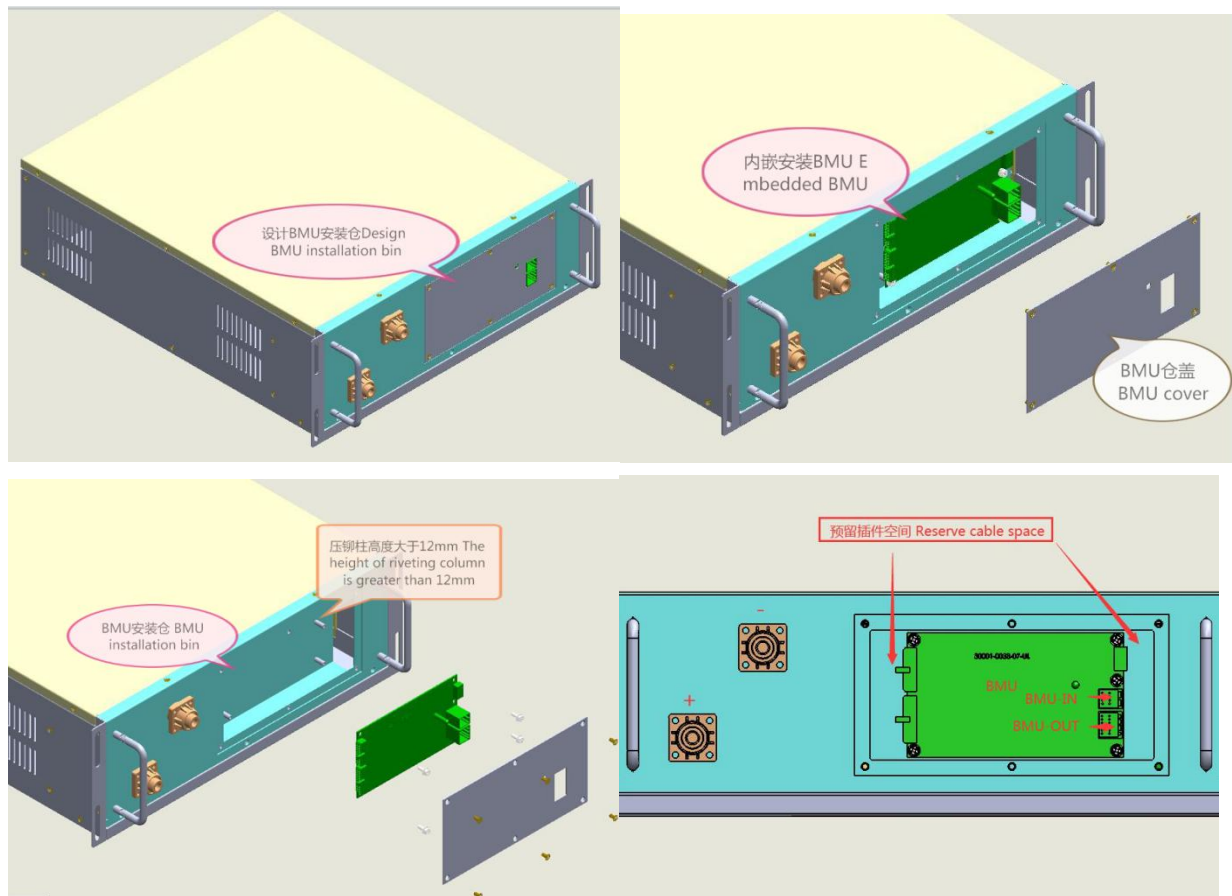

3.2 BMU 外置安装 External installation

如果不方便设计内嵌 BMU 安装仓，可选配 BMU 金属盒，外形尺寸见下图一。安装在电池箱外部，安装方式参考下图二。

If it is not convenient to design the embedded BMU installation bin, the BMU metal box can be selected. The overall dimensions are shown in Figure 1 below. It is installed outside the battery box. The installation method is shown in Figure 2 below.

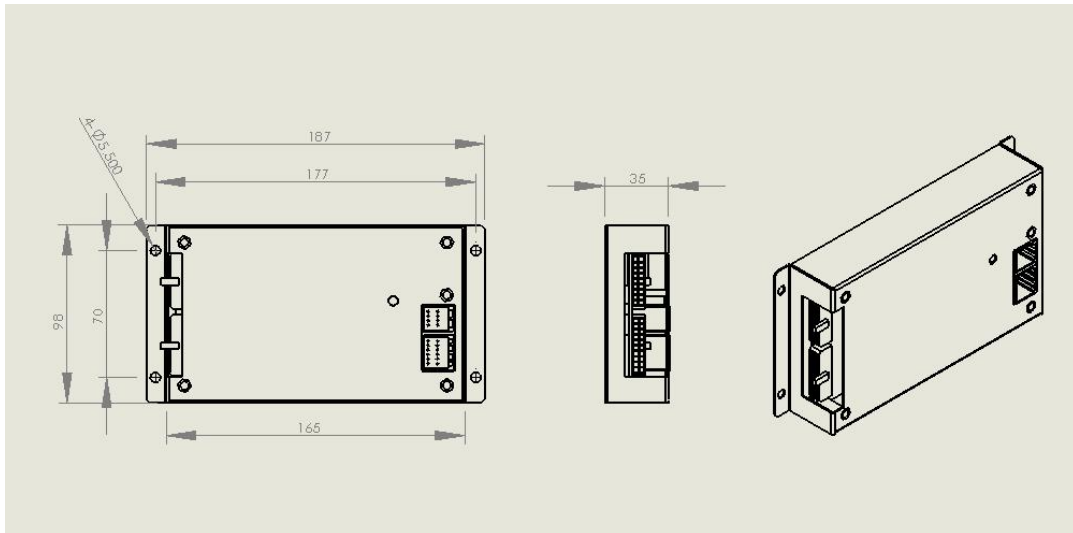

4 接口定义 Interface Definition

4.1 12~16S BMU picture and interface location



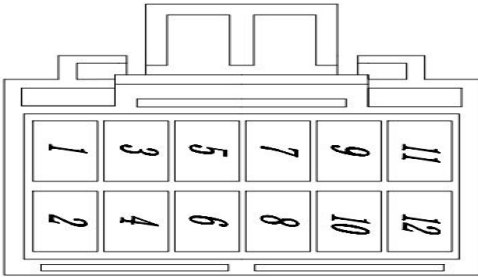
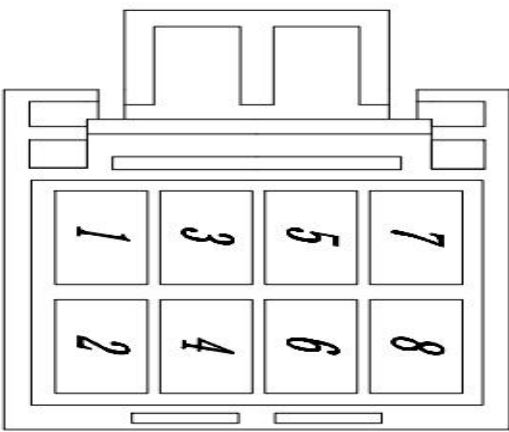
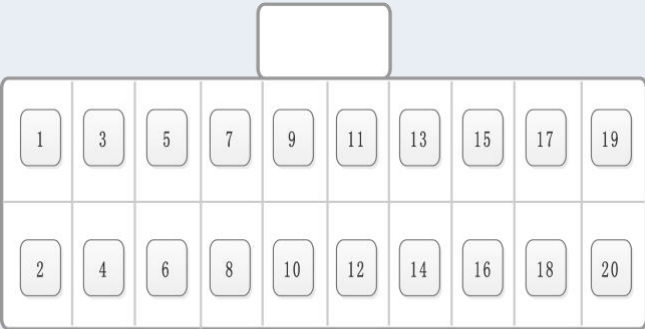

4.1 12~16S BMU Interface Definition

Interface	Definition	Description
J2	<p>2*9P</p>	1~2: 8号温感(RT8) Temperature 8
		3~4: 7号温感(RT7) Temperature 7
		5~6: 6号温感(RT6) Temperature 6
		7~8: 5号温感(RT5) Temperature 5
		9~10:未连接 No connection
		11: 10号电芯正极(B10+) Positive of cell 10
		12: 9号电芯正极(B9+) Positive of cell 9
		13:12号电芯正极 (B12+) Positive of cell 12
		14: 11号电芯正极(B11+) Positive of cell 11
		15: 14号电芯正极(B14+)

		<p>Positive of cell 14</p> <p>16: 13 号电芯正极(B13+)</p> <p>Positive of cell 13</p> <p>17: 16 号电芯正极(B16+)</p> <p>Positive of cell 16</p> <p>18: 15 号电芯正极(B15+)</p> <p>Positive of cell 15</p>
<p>J5-1</p>		<p>1 & 3: 硬件 ID 分配信号输出 Hardware signal out of ID assignment for 1 & 3</p> <p>2: CAN_L 信号 CAN_L signal</p> <p>4: CAN_H 信号 CAN_H signal</p> <p>5~6: 未连接 No connection</p> <p>7~8: 12V 电源负极 Negative of 12V power from BMS</p> <p>9~10: 12V 电源正极 Positive of 12V power from BMS</p> <p>11~12: 未连接 Not connect</p>
<p>J5-2</p>		<p>1, 3: 硬件 ID 分配信号输入 Hardware signal in of ID assignment</p> <p>2: CAN_L 信号 CAN_L signal</p> <p>4: CAN_H 信号 CAN_H signal</p> <p>5~6: 12V 电源负极 Negative of 12V power from BMS</p> <p>7~8: 12V 电源负极 Negative of 12V power from BMS</p>
<p>J1</p>	 <p style="text-align: center;">2*x10P</p>	<p>1~2: 4 号温感(RT4) Temperature 4</p> <p>3~4: 3 号温感(RT3) Temperature 3</p> <p>5~6: 2 号温感(RT2) Temperature 2</p> <p>7~8: 1 号温感(RT1) Temperature 1</p> <p>9~10: 未连接 No connection</p> <p>11~12: 1 号电芯负极(B1-) Negative of Cell 1</p> <p>13: 2 号电芯正极(B2+) Positive of cell 2</p> <p>14: 1 号电芯正极(B1+) Positive of cell 1</p> <p>15: 4 号电芯正极(B4+) Positive of cell 4</p> <p>16: 3 号电芯正极(B3+) Positive of cell 3</p> <p>17: 6 号电芯正极(B6+) Positive of cell 6</p>

		18: 5 号电芯正极(B5+) Positive of cell 5 19: 8 号电芯正极(B8+) Positive of cell 8 20: 7 号电芯正极(B7+) Positive of cell 7
J8		1: 模组总正极 B+ Total positive 2: 模组总负极 B- Total negative 3: 风扇正极 FAN+ Fan positive 4: 风扇负极 FAN- Fan negative
+, -	模组总正极和总负极 Positive and negative of whole battery module	
BMU_IN	级联通信输入 Cascade communication input	必须连接到上一个模组的 BMU_IN Must connect to oster module' s BMU_OUT or CBMS' s BMU_OUT
BMU_OUT	级联通信输出 Cascade communication output	必须连接到下一个模组的 BMU_OUT Must connect to other module' s BMU_IN 注意: 最后一个模组的此端口必须插入终端匹配电阻, 否则可能会导致通信不稳定。 Note: The terminal matching resistor must be inserted into this port of the last module, otherwise it may cause unstable communication
指示灯 indicator light	绿色闪烁 Flashing green	表示 BMU 正常工作 Indicates that the BMU is working normally

5. BMU 配件清单 Accessories list

名称 name	规格 Specifications	数量 qty	图例 picture
18p 采集线 18p acquisition harness	标准长度 600mm 和 900mm 可选. 600mm and 900mm optional	1	
20p 采集线 20p acquisition harness	标准长度 600mm 和 900mm 可选. 600mm and 900mm optional	1	
BMU 通信线 BMU communication harness	标准长度 180mm , 300mm, 600mm 可选 180mm.300mm and 600mm optional	1	
风扇线束 Fan harness	标准长度 600mm Standard length 600mm	1	

注意：表中数量指一套 BMU 所含配件数量

Note: the quantity in the table refers to the number of accessories contained in a BMU

6. 注意事项 Precautions

1)、安装及调试人员所使用的工具须有绝缘防护。The tools used by the installation and commissioning personnel must be insulated.

2)、在安装调试及维护时必须戴绝缘橡胶手套，视情况穿戴护目镜、绝缘橡胶靴，尽可能避免安全事故的发生。Insulation rubber gloves must be worn during installation, commissioning and maintenance. Wear eye protection glasses and insulated rubber boots as appropriate to avoid safety accidents.

3)、安装调试及维护过程中产生的线头金属等如掉入电池间，请务必使用绝缘工具取出，不能将杂物留置。If the lead metal that has occurred during the installation, debugging, or maintenance is dropped into the battery, be sure to remove it with an insulating tool and do not leave any foreign matter in it.

4)、确保严格按照接线指示进行操作否则可能会损坏 BMU。Be sure to follow the wiring instructions, otherwise it may damage the circuit board

5)、尽量避免长期在下列工作环境中使用。Try to avoid long-term use in the following working environments:

- ◎ 超过规格书规定的温度或湿度范围的场所

Locations that exceed the temperature or humidity range specified in the specification

- ◎ 有强烈震动或易受撞击的场所

Sites that are strongly vibrated or susceptible to impact

◎ 阳光直射或靠近热源的场所

Places exposed to direct sunlight or near heat sources

◎ 有粉尘、强腐蚀性物质、易燃易爆物、高盐雾场所

Dust, strong corrosive substances, flammable and explosive, high salt fog

7. 免责声明 Disclaimer

湖南群控能源科技有限公司对此产品规格书拥有最终解释权,并有权对此规格书进行修订。
产品规格如有变更,恕不另行通知。

The company(Hunan Group Control Energy Technology Co., Ltd) has the final interpretation of this product specification and has the right to revise this specification. Product specifications are subject to change without notice. If necessary, please contact the supplier to confirm if there is the latest specification.